

 fitbit charge 2™



User Manual  
Version 1.3

# Table of Contents

- Getting Started..... 1**
  - What you'll find in the box .....1
  - What's in this document .....1
- Setting up your Fitbit Charge 2 ..... 2**
  - Setting up your tracker on your phone or tablet .....2
  - Setting up your tracker on your Windows 10 PC.....2
  - Setting up your tracker on your Mac.....3
  - Syncing your tracker data to your Fitbit account..... 4
- Getting to know your Fitbit Charge 2.....5**
  - Wrist placement.....5
    - All-day wear and exercise .....5
    - Wrist choice and dominant hand..... 6
  - Navigation..... 6
    - Waking a dimmed screen .....7
    - Using the clock and menus .....7
    - Tapping your tracker..... 8
  - Battery life and charging ..... 9
    - Finding your current battery level..... 9
    - Charging your tracker ..... 9
  - Care .....10
  - Changing the wristband.....10
    - Removing a wristband .....10
    - Attaching a new wristband ..... 11
- Automatic tracking with Fitbit Charge 2..... 13**
  - Viewing all-day stats ..... 13

Viewing your heart rate.....	13
Using heart-rate zones .....	13
Default heart-rate zones .....	14
Custom heart-rate zones .....	15
Tracking a daily activity goal.....	15
Choosing a goal.....	15
Seeing goal progress.....	15
Tracking hourly activity.....	16
<b>Sleep Tracking .....</b>	<b>17</b>
Setting sleep goals.....	17
Setting up bedtime reminders .....	17
Learning about your sleep habits .....	17
<b>Exercising with Fitbit Charge 2.....</b>	<b>18</b>
Using SmartTrack .....	18
Using the Exercise menu.....	18
GPS requirements.....	18
Tracking exercise.....	19
<b>Practicing Guided Breathing with Charge 2 .....</b>	<b>20</b>
<b>Using Silent Alarms.....</b>	<b>21</b>
Enabling or disabling silent alarms.....	21
Dismissing silent alarms .....	21
<b>Receiving Call, Text, &amp; Calendar Notifications .....</b>	<b>22</b>
Calendar requirements .....	22
Enabling notifications.....	22
Viewing incoming notifications .....	23
<b>Customizing your Fitbit Charge 2 .....</b>	<b>25</b>

Changing the clock face.....	25
Using Quick View.....	25
Adjusting the heart rate tracker.....	25
<b>Updating your Fitbit Charge 2 .....</b>	<b>27</b>
<b>Troubleshooting your Fitbit Charge 2.....</b>	<b>28</b>
Heart-rate signal missing.....	28
Unexpected behavior.....	28
<b>Fitbit Charge 2 General Info &amp; Specifications .....</b>	<b>30</b>
Sensors.....	30
Materials.....	30
Wireless technology.....	30
Haptic feedback.....	30
Battery.....	30
Memory .....	30
Display.....	31
Size .....	31
Environmental conditions.....	32
Learn More .....	32
Return policy and warranty .....	32
<b>Regulatory &amp; Safety Notices.....</b>	<b>33</b>
USA: Federal Communications Commission (FCC) statement .....	33
Canada: Industry Canada (IC) statement.....	34
European Union (EU) .....	34
Australia and New Zealand .....	35
China .....	35
Israel.....	36

Japan..... 36

Mexico ..... 37

Morocco ..... 37

Oman ..... 37

Philippines ..... 37

Serbia..... 38

Singapore ..... 38

South Africa..... 38

South Korea ..... 38

Taiwan ..... 39

United Arab Emirates..... 40

Safety statement..... 40

# Getting Started

---

Welcome to Fitbit Charge 2, the smart fitness band that helps you reach your goals in style. Take a moment to review our complete safety information at <http://www.fitbit.com/safety>.

## What you'll find in the box

Your Fitbit Charge 2 box includes:



Tracker



Charging cable

The top and bottom detachable wristbands can be swapped for other colors and materials sold separately.

## What's in this document

We get you started quickly by creating a Fitbit account and making sure your tracker can transfer the data it collects to your dashboard. The dashboard is where you'll set goals, analyze historical data, identify trends, log food and water, keep up with friends, and much more. As soon as you're done setting up your tracker, you're ready to start moving.

Next, we explain how to find and use the features that interest you and adjust your preferences. To find more information, tips, and troubleshooting, please browse our comprehensive articles at [help.fitbit.com](http://help.fitbit.com).

# Setting up your Fitbit Charge 2

---

For the best experience we recommend using the Fitbit app for iOS, Android, or Windows 10. If you don't have a phone or tablet, you can also use a Bluetooth-enabled Windows 10 PC or Mac. For non-Bluetooth options visit [help.fitbit.com](http://help.fitbit.com).

Your Fitbit account asks for information such as height, weight, and sex to make various calculations such as stride lengths to estimate distance and basal metabolic rate to estimate calorie burn. You have the option to share your age, height, or weight with Fitbit friends but the information you provide is private by default.

## Setting up your tracker on your phone or tablet

The free Fitbit app is compatible with more than 200 phones and tablets that support iOS, Android, and Windows 10 operating systems.

To get started:

1. Make sure the Fitbit app is compatible with your phone or tablet by checking <http://www.fitbit.com/devices>.
2. Find the Fitbit app in one of these locations, depending on your device:
  - The Apple App Store for iOS devices such as an iPhone or iPad.
  - The Google Play Store for Android devices such as the Samsung Galaxy S5 and Motorola Droid Turbo.
  - The Microsoft Store for Windows 10 devices such as the Lumia phone or Surface tablet.
3. Install the app. Note that if you don't have an account with the store you'll be required to create one before you can download the app.
4. When the app is installed, open it and tap **Join Fitbit** to be guided through a series of questions that help you create your Fitbit account, or login to your existing account.
5. Continue following the onscreen instructions to connect, or *pair*, your Charge 2 to your phone or tablet. Pairing makes sure the tracker and phone or tablet can communicate with one another (sync data back and forth).

When you're done pairing, read through the guide about your new tracker and then explore the Fitbit dashboard.

## Setting up your tracker on your Windows 10 PC

If you don't have a phone or tablet, you can set up and sync your tracker using a Bluetooth-enabled Windows 10 PC. The same Fitbit app that is available for Windows 10 phones and tablets is available for your computer.

To get the Fitbit app for your computer:

1. Click the Start button on your PC and open the Microsoft Store (called Store).
2. Search for “Fitbit app” and when you find it, click **Free** to download the app to your computer.
3. If you’ve never downloaded an app to your computer, you’ll be prompted to create an account with the Microsoft Store.
4. Click **Microsoft account** to sign in with your existing Microsoft account. If you don’t already have an account with Microsoft, follow the onscreen instructions to create a new account.
5. Open the app after it’s done downloading.
6. Click **Join Fitbit** to be guided through a series of questions that help you create a Fitbit account, or login to your existing account.
7. Continue following the onscreen instructions to connect, or *pair*, your Charge 2 with the Windows 10 app. Pairing makes sure the tracker and app can communicate with one another (sync data back and forth).

When you’re done pairing, read through the guide about your new tracker and then explore the Fitbit dashboard.

## Setting up your tracker on your Mac

If you don’t have a compatible phone or tablet, you can set up your tracker with a Bluetooth-enabled Mac and use the fitbit.com dashboard to see your stats. To use this method you’ll first install a free software application called Fitbit Connect that lets Charge 2 sync its data with your fitbit.com dashboard.

To install Fitbit Connect and set up your tracker:

1. Go to <http://www.fitbit.com/setup>.
2. Scroll down and click the option to download. If the button does not correctly show your type of computer (for example, if it says “Download for Mac”), choose the correct type, then click the button.
3. You’ll see an option to open or save a file; choose open. After several seconds you’ll see an option to install Fitbit Connect.

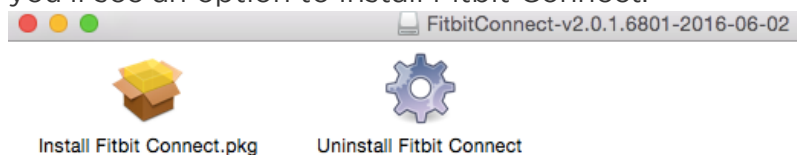

4. Double-click Install Fitbit Connect.pkg. The Fitbit Connect installer opens.
5. Click **Continue** to move through the installer.
6. When prompted, choose **Set up a New Fitbit Device**.
7. Follow the onscreen instructions to create a Fitbit account, or login to your existing account, and connect your tracker with Fitbit Connect.



When you're done with the setup steps, Fitbit guides you through an introduction to your new Charge 2 and then takes you to the fitbit.com dashboard.

## Syncing your tracker data to your Fitbit account

When you start using your Charge 2 you'll need to regularly sync it with your Fitbit dashboard. The dashboard is where you'll track progress, see your exercise history, track your sleep patterns, participate in challenges, and much more. We recommend syncing at least once a day.

The Fitbit apps and Fitbit Connect use Bluetooth Low Energy (BLE) technology to sync with your Fitbit tracker.

Each time you open the Fitbit app, it syncs automatically if the paired tracker is nearby. You can also use the [Sync Now](#) option in the app at any time.

Fitbit Connect syncs every 15 minutes if the tracker is within 20 feet of the computer. To force a sync, click the Fitbit Connect icon located near the date and time on your computer and choose [Sync Now](#).

# Getting to know your Fitbit Charge 2

---

This section tells you how best to wear, navigate, and charge your tracker. If you bought an accessory wristband, you'll also find instructions for taking off the original band and putting on a different one.

## Wrist placement

Review these tips to make sure you're wearing your tracker for optimal results.

### All-day wear and exercise

For all-day wear when you're not exercising, your Charge 2 should usually rest a finger's width below your wrist bone and lay flat, as you would normally wear a watch.

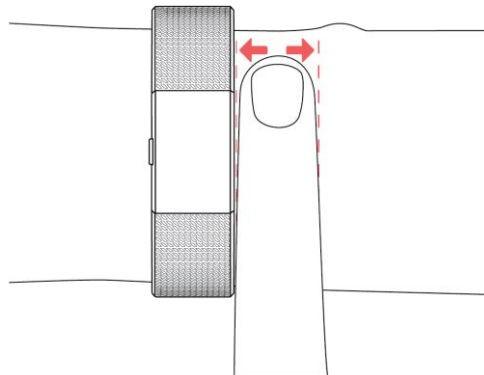

For optimized heart rate tracking keep these tips in mind:

1. Experiment with wearing the tracker higher on your wrist during exercise. Because blood flow in your arm increases the farther up you go, moving the tracker up a couple inches can improve the heart rate signal. Also, many exercises such as bike riding or weight lifting cause you to bend your wrist frequently, which is more likely to interfere with the heart rate signal if the tracker is lower on your wrist.

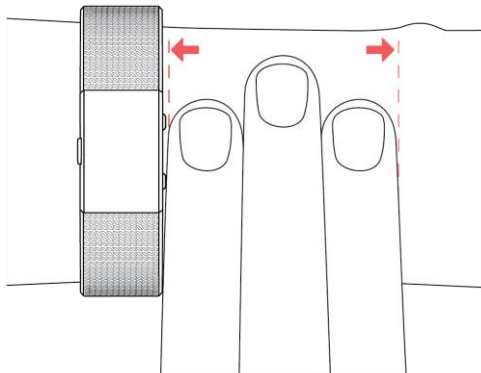

2. Do not wear your tracker too tight; a tight band restricts blood flow, potentially affecting the heart rate signal. That being said, the tracker should also be slightly tighter (snug but not constricting) during exercise than during all-day wear.
3. With high-intensity interval training or other activities where your wrist is moving vigorously and non-rhythmically, the movement may limit the sensor's ability to provide a heart rate reading. Similarly, with exercises such as weight lifting or rowing, your wrist muscles may flex in such a way that the band tightens and loosens during exercise. If your tracker does not show a heart rate reading, try relaxing your wrist and staying still briefly (about 10 seconds), after which you should see a heart rate reading.

## Wrist choice and dominant hand

For greater accuracy, your tracker needs to know which wrist you wear it on (right or left) and which hand you consider dominant (right or left). Your dominant hand is the one you usually write or throw with.

During setup you're asked to choose the wrist where you're going to wear your tracker. Should you later decide to move your tracker to the other wrist, change the Wrist setting. You can also change your dominant hand at any time with the Handedness setting. Both settings are found in the Account section of the Fitbit app or in the Personal Info section of your fitbit.com dashboard settings.

## Navigation

Charge 2 has an OLED tap display and one button.

## Waking a dimmed screen

When you're not using Charge 2 the display is off. To wake it up:

- Press the button
- Turn your wrist towards you. This behavior, known as Quick View, can be turned off in your tracker settings.
- Double-tap your tracker.

## Using the clock and menus

The default or “home” screen is a clock, which is available in several styles. On the clock screen you can:

- Tap to see your steps taken, heart rate, distance, calories burned, floors climbed, active minutes, and hourly activity.
- Press the button to move to through the menus.
- Press and hold the button to turn on or turn off notifications, including reminders to move.



You can customize the both the stats and menus shown on your tracker. For more information, see [help.fitbit.com](https://help.fitbit.com).

After viewing the clock screen, you can cycle through the different menus to see information or use different functions on your tracker. The following menus are available:

- Heart rate—Shows your current heart rate. Tap to see your resting heart rate.
- Exercise—Tap to move through your exercise choices, then press and hold the button to start the selected exercise. Press and hold the button again to end the exercise.
- Relax—Tap to choose a guided breathing session. Press and hold the button to start the session.
- Stopwatch—Press and hold the button to start the stopwatch. Press the button to stop and resume the stopwatch. Press and hold the button again to reset the stopwatch.

- Alarms—Tap to scroll through any alarms you’ve set. Press and hold the button to disable or enable any alarms. The alarm screen appears only when you have alarms set.
- Notifications—Press and hold the button to turn on or turn off notifications. If you turn off notifications, your tracker will not alert you when you receive a phone call, text message, or calendar alert on your phone, nor will you receive reminders to move.
- Battery—Shows the percentage of battery life remaining on your tracker. The battery screen appears only if you turn it on in your tracker settings.



## Tapping your tracker

For best results, tap your tracker where the screen meets the band as shown. To wake up your tracker, double-tap it; to flip through your stats or the menus, single-tap it.

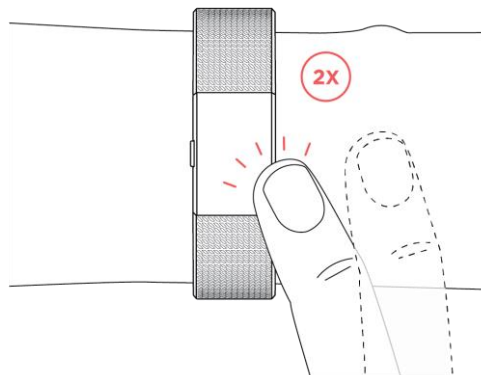

Charge 2 doesn’t respond to swipes. You must use the button or firmly and quickly tap the screen.

## Battery life and charging

Your fully charged Charge 2 has a battery life of up to five days. Battery life and charge cycles vary with use and other factors; actual results will vary.

### Finding your current battery level

If your battery is low, when you wake up your Charge 2 you'll see a low battery icon after a few seconds. If you see a critical battery icon you'll be unable to navigate to any of the tracker screens until you charge your tracker. Your tracker continues to track your activity until your battery runs out.

You can check your battery level at any time on the battery screen on your tracker or on your Fitbit dashboard. To see the battery screen you must turn on the battery menu item in the Fitbit app.

### Charging your tracker

To charge your tracker:

1. Plug the charging cable into the USB port on your computer or a UL-certified USB wall charger.
2. Clip the other end of the charging cable to the port on the back of the tracker. The pins on the charging cable must lock securely with the port.

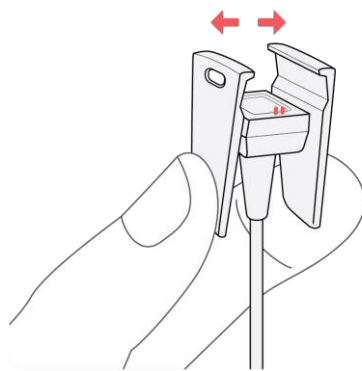

3. Make sure the button on your tracker is aligned with the button opening on the charging cable. You'll know the connection is secure when the tracker vibrates and you see a battery icon on your tracker's display. The battery icon

disappears after three seconds.

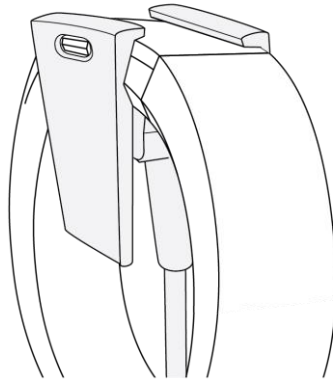

Charging fully takes about one to two hours. While the tracker charges, you can tap it to check the battery level. A fully charged tracker shows a solid battery icon.

## Care

It's important to clean and dry your Charge 2 regularly. For instructions and more information, see <http://www.fitbit.com/productcare>.

## Changing the wristband

The wristband has two separate bands (top and bottom) that you can swap with accessory bands sold separately.

### Removing a wristband

To remove the wristband:

1. Turn over your Charge 2 and find the band latches—there's one on each end where the band meets the frame.
2. To release the latch, press down on the flat metal button on the strap.

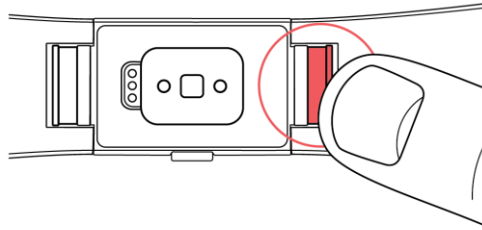

3. Slide the band up to release it from the tracker.

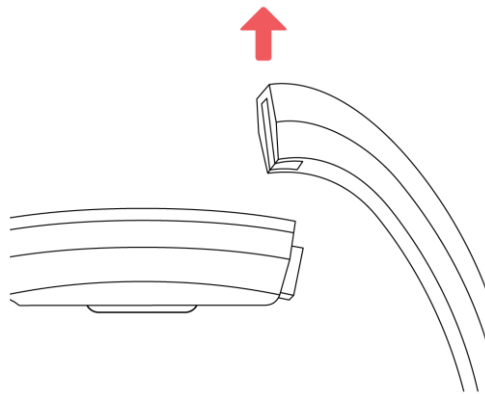

4. Repeat on the other side.

If you're having trouble removing the band or if it feels stuck, gently move the band back and forth to release it.

### Attaching a new wristband

Before you attach a new wristband, first identify the top and bottom bands. The top band has a watch buckle at the end of it. The bottom band has notches and should be attached on the side closest to the charging port.

To attach a band, slide it down on the end of the tracker until you feel it snap into place.



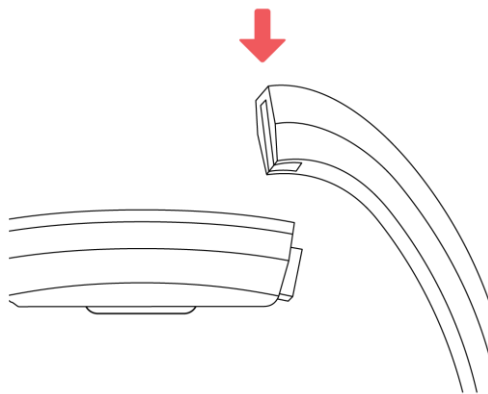

# Automatic tracking with Fitbit Charge 2

---

Your Charge 2 continuously tracks a variety of stats whenever you have it on. The information is transferred to your dashboard every time you sync your tracker.

## Viewing all-day stats

Press the button to wake up your Charge 2 and see the time of day. Tap the screen to see each of these all-day stats:

- Steps taken
- Current heart rate
- Distance covered
- Calories burned
- Floors climbed
- Active minutes
- Hourly activity

On your Fitbit dashboard you can find other information captured by your tracker, such as:

- Your sleep history, including hours slept and sleep patterns
- The hours of your day that you were stationary vs. active (walked at least 250 steps)
- Your exercise history and progress towards a weekly exercise goal
- Your beats per minute (BPM), average resting heart rate, and time spent in heart-rate zones

---

Note: Charge 2 resets at midnight to begin a new day.

---

## Viewing your heart rate

Charge 2 allows you to view your real-time heart rate and your resting heart rate on your tracker. To view your heart rate, press the button until you get to the Heart rate screen where you'll see your current heart rate. Tap to see your resting heart rate.

## Using heart-rate zones



Heart-rate zones help you target the training intensity of your choice. Your tracker shows your current zone above your heart rate, and on your Fitbit dashboard you can see your time spent in zones during a particular day or exercise. Three zones

based on American Heart Association recommendations are available by default, or you can create a custom zone if you have a specific heart rate you're targeting.

## Default heart-rate zones

Default heart-rate zones are calculated using your estimated maximum heart rate. Fitbit calculates your maximum heart rate with the common formula of 220 minus your age.

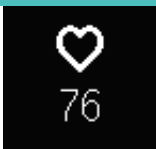
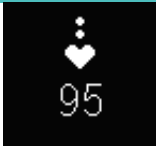
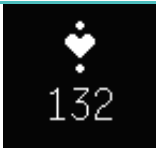
The heart icon you see above your current heart rate tells you your zone. Refer to the following table for an explanation of the different heart rate zones.

Icon	Zone	Calculation	Description
	<b>Out of Zone</b>	Below 50% of your maximum heart rate.	Your heart rate may be elevated but not enough to be considered exercise.
	<b>Fat Burn</b>	Between 50% and 69% of your maximum heart rate.	Low-to-medium intensity exercise zone. This zone may be a good place to start for those new to exercise. It's called the Fat Burn zone because a higher percentage of calories are burned from fat, but the total calorie burn rate is lower.
	<b>Cardio</b>	Between 70% and 84% of maximum heart rate.	Medium-to-high intensity exercise zone. In this zone you're pushing yourself but not straining. For most people this is the exercise zone to target.
	<b>Peak</b>	Greater than 85% of your maximum heart rate.	High-intensity exercise zone. This zone is for short intense sessions that improve

performance and speed.

## Custom heart-rate zones

Instead of using the default heart-rate zones, you can configure a custom zone or a custom max heart rate if you have a specific target in mind. For example, elite athletes might have a target that differs from the American Heart Association's recommendations for the average person. When you're in your custom zone you'll see a solid heart on your tracker. When you're not in the zone you'll see an outline of a heart.

For more details about heart rate tracking, including links to relevant American Heart Rate Association information, see [help.fitbit.com](https://help.fitbit.com).

## Tracking a daily activity goal

Your Charge 2 tracks your progress towards a daily activity goal of your choice. When you reach your goal, the tracker vibrates and shows a celebration.

### Choosing a goal

By default your goal is 10,000 steps per day. You can change the goal to distance traveled, calories burned, active minutes, or floors climbed and select the corresponding value you prefer. For example, you may want to keep steps as your goal but change the target from 10,000 to 20,000 steps.

### Seeing goal progress

A goal progress bar helps keep you motivated. The filled in portion of the bar shown below indicates that you're more than halfway to your goal.



## Tracking hourly activity

Charge 2 helps keep you active throughout the day by keeping track of when you're stationary and reminding you to move.

If you haven't walked at least 250 steps in a given hour, at ten minutes before the hour you'll feel a vibration reminding you to walk. When you meet the 250-step goal after receiving a reminder, you'll feel a second vibration and see a congratulatory message. You'll also see a daily celebration if you meet your goal every hour.



Hourly  
Celebration



Daily  
Celebration

# Sleep Tracking

---

Wear your Charge 2 to bed to automatically track both your time spent asleep and your sleep quality. To see your sleep information, sync your tracker when you wake up and check your dashboard.

For more details about sleep tracking see [help.fitbit.com](https://help.fitbit.com).

## Setting sleep goals

By default, you have a customizable sleep goal of 8 hours of sleep per night. For more information about your sleep goal, including how to change it, see [help.fitbit.com](https://help.fitbit.com).

## Setting up bedtime reminders

Your Fitbit dashboard can recommend consistent bedtimes and wake times to help you improve the consistency of your sleep cycle. You can even choose to be reminded nightly when it's time to start winding down for bed.

For more information about setting up bedtime reminders, see [help.fitbit.com](https://help.fitbit.com).

## Learning about your sleep habits

Your Charge 2 tracks several sleep metrics including how long you're asleep and time spent in each sleep stage. When used with the Fitbit dashboard, your Charge 2 can help you understand how your sleep patterns compare to others of the same sex and age range. For more information about what happens when you're asleep, see [help.fitbit.com](https://help.fitbit.com).

# Exercising with Fitbit Charge 2

---

Charge 2 uses SmartTrack to automatically detect and record select exercises. For more precision or to see real-time stats and a workout summary right on your wrist, you can tell your tracker when exercise starts and stops. All workouts appear in your exercise history for deeper analysis and comparison.

## Using SmartTrack

SmartTrack ensures you get credit for your most active moments of the day. When you sync your tracker after a SmartTrack-detected exercise, you can find several stats in your exercise history including duration, calories burned, impact on your day, and more.

By default, SmartTrack detects continuous movement at least 15 minutes in length. You can increase or decrease the minimum duration or disable SmartTrack for one or more exercise types. For more information about customizing and using SmartTrack, see [help.fitbit.com](https://help.fitbit.com).

## Using the Exercise menu

You can choose from over a dozen exercise types to customize the Exercise menu with your favorites. Some exercises, like running, biking, and hiking have a GPS option.

For more information about customizing your Exercise menu, see [help.fitbit.com](https://help.fitbit.com).

---

Note: Charge 2 does not have built-in GPS. Its *connected GPS* feature works with the GPS sensors on your nearby phone to give you real-time pace and distance information, as well as recording a map of your route. Turning on connected GPS enables more precise tracking of your exercise stats.

---

## GPS requirements

For more information about setting up connected GPS, see [help.fitbit.com](https://help.fitbit.com).

1. If you're going to use connected GPS, make sure Bluetooth and GPS are both enabled on your phone and that your tracker is paired to your phone.
2. Make sure the Fitbit app has permission to use GPS or location services.
3. Verify that connected GPS is turned on for the exercise in the Fitbit app.

- a. Find the Exercise shortcuts in the Fitbit app. For more information see, [help.fitbit.com](https://help.fitbit.com).
- b. Tap the exercise you want to track and make sure Connected GPS is turned on.

## Tracking exercise

To track an exercise:

1. On your tracker, press the button until you get to the Exercise screen and then tap to find the exercise of your choice.
2. Press and hold the button to start the exercise. If you see a phone icon at the top, that exercise offers connected GPS and your device is connected to a GPS signal. If the phone icon is crossed out, a GPS connection isn't available. An animated dashed line means your device is trying to find a GPS signal.

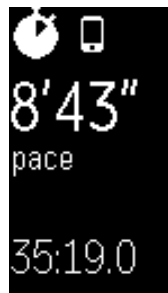

GPS signal connected

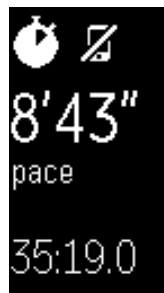

GPS signal disconnected

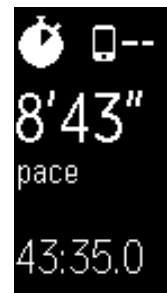

Searching for GPS signal

3. During your workout, tap your tracker to scroll through your real-time stats or check the time of day.
4. To pause your workout, press the button. Then press the button again to resume the exercise."
5. When you're done with your workout, press and hold the button to stop recording. You'll see a flag icon and a congratulatory message.
6. Press the button to see a summary of your results. With each button press you'll cycle to a different set of stats. You can view your exercise summary one time.

Syncing your tracker stores the workout in your exercise history. There you can find additional stats and see your route if you used connected GPS.



# Practicing Guided Breathing with Charge 2

---

Charge 2 provides personalized guided breathing sessions on your tracker to help you find moments of calm throughout the day. You can choose between two-minute and five-minute long sessions.

To begin a session:

1. On your tracker, press the button until you get to the Relax screen.
2. The two-minute session is the first option. Tap to choose the five-minute session.
3. Press and hold the button to start.
4. Remain still and breathe deeply during the calibration period, which lasts 30-40 seconds. You'll see the phrase "sensing your breathing" on your tracker's screen.
5. When prompted, inhale and exhale deeply.



Sparkles will appear on your tracker's screen to indicate how closely you're following the guide. If you feel dizzy or uncomfortable, stop the guided breathing session.

6. After you've completed the session, press the button to return to the clock.

All notifications are automatically disabled during the session. If you've set a silent alarm, your Charge 2 will vibrate at the time specified.

For more information about guided breathing sessions, including the benefits of practicing deep breathing and safety information, see [help.fitbit.com](https://help.fitbit.com).

# Using Silent Alarms

---

Charge 2 can gently vibrate to wake or alert you with its silent alarm feature. You can set up to eight alarms to recur every day or on particular days of the week only.

For more information about customizing and using silent alarms, see [help.fitbit.com](https://help.fitbit.com).

## Enabling or disabling silent alarms

Once an alarm has been set, you can disable or re-enable it directly on your Charge 2 without opening the Fitbit app. You can only set an alarm in the Fitbit app.

1. Press the button on your tracker until you find the Alarms screen.



2. Tap your tracker until you find the alarm you're looking for.
3. Press and hold the button to disable or enable the alarm.

## Dismissing silent alarms

The tracker flashes and vibrates when an alarm goes off. To dismiss the alarm, press the button on your tracker or walk 50 steps. If you don't press the button during the alarm, it will automatically repeat once.

# Receiving Call, Text, & Calendar Notifications

---

Over 200 compatible phones let you receive incoming phone call, text message, and calendar event notifications on your Charge 2 when your phone is nearby. To determine whether your device supports this feature, go to <http://www.fitbit.com/devices>.

## Calendar requirements

Your tracker will show calendar events and any information sent from your calendar app to your phone. Note that if your calendar app does not send notifications to your phone, you won't receive notifications on your tracker.



If you have an iOS or Windows 10 phone, your Charge 2 shows notifications from all calendars synced to the default Calendar app. If you have a third-party calendar that is not synced to the default Calendar app, you won't see notifications from that calendar.

If you have an Android device, your Charge 2 shows calendar notifications from the calendar app you choose during setup. You can choose from the default Calendar app on your phone or several third-party calendar apps.

## Enabling notifications

Before you turn on notifications in the Fitbit app, make sure that Bluetooth on your phone is turned on and that your phone is capable of sending notifications (often under Settings > Notifications).

For more information about making sure your phone permits notifications, see [help.fitbit.com](http://help.fitbit.com).

Call and text notifications are on by default. To turn on calendar notifications:

1. With your tracker nearby, on the Fitbit app dashboard, tap the Account icon ( ).
2. Tap the Charge 2 tile.
3. Tap **Notifications** and turn on or off any combination of text, call, or calendar notifications.
4. Follow the onscreen instructions to connect (bond) your phone with your tracker.

After notifications are enabled, “Charge 2” appears in the list of Bluetooth devices paired to your phone.

---

Note: If this is your first time setting up notifications on your Android phone, for detailed instructions, see [help.fitbit.com](https://help.fitbit.com).

---

## Viewing incoming notifications

If your tracker and phone are within 30 feet of each other, a call, text message, or calendar event causes the tracker to vibrate. Your screen will remain off until you wake it up to view the notification. To wake up your tracker and view the notification, turn your wrist towards you or press the button. The notification is only available for one minute after you receive it. If you have more than one unread notification, you’ll see a plus sign (+) indicator.

For phone calls, the notification scrolls four times with the name or number of the caller while an animation plays. To dismiss the notification, press the button.



For text messages the message scrolls one time and then disappears. The sender’s name scrolls once and remains static.

For calendar events, the name of the event scrolls one time and then disappears. The event time scrolls once and remains static.

If the text message, calendar event, sender or event time, is short enough to show on the screen, the information does not scroll. The character limit for notifications is 40.



## Customizing your Fitbit Charge 2

---

This section explains how to change your clock face and modify certain tracker behaviors.

### Changing the clock face

Charge 2 comes with several clock faces. Some examples include:

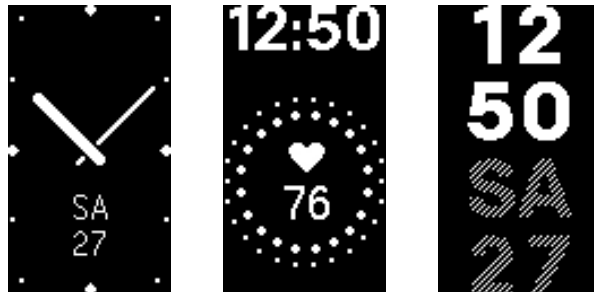

You can change your clock face using the Fitbit app or the [fitbit.com](https://www.fitbit.com) dashboard. For more information, see [help.fitbit.com](https://help.fitbit.com).

### Using Quick View

To preserve battery your screen turns off when not in use. It wakes up automatically when you turn your wrist towards you (known as Quick View), or you can wake it up by pressing the button or double tapping.

For more information about turning Quick View on or off, see [help.fitbit.com](https://help.fitbit.com).

### Adjusting the heart rate tracker

Your Charge 2 uses PurePulse® technology to track heart rate automatically and continuously. The Heart Rate setting has three options:

- Auto (the default)—Heart rate tracking is active when you're wearing your tracker.
- Off—Heart rate tracking is off.
- On—Heart rate tracking is on regardless of whether you're wearing your tracker.

For more information about adjusting the heart rate tracker, see [help.fitbit.com](https://help.fitbit.com).

## Updating your Fitbit Charge 2

---

We occasionally make free feature enhancements and product improvements available through firmware updates. We recommend keeping your Charge 2 up to date.

When a firmware update is available you'll see a notification in the Fitbit app prompting you to update. When the update starts, a progress bar appears on the tracker and in the Fitbit app until the update is complete.

Keep your tracker and phone close to each other during the update process.

---

Note: Updating your Charge 2 takes several minutes and may be demanding on the battery. For this reason we recommend updating while your tracker is fully charged or plugged into the charging cable.

---



# Troubleshooting your Fitbit Charge 2

---

If your tracker is not working properly, review our troubleshooting guidance below.

Visit [help.fitbit.com](https://help.fitbit.com) more information.

## Heart-rate signal missing

Charge 2 continuously tracks your heart rate while you're exercising and throughout the day. Occasionally the heart rate tracker may have difficulty finding a good signal. When this happens you'll see dashed lines where your current heart rate usually appears



Heart rate signal missing

If you're not getting a heart rate signal, first make sure you're wearing your tracker correctly, either moving it higher or lower on your wrist or tightening or loosening the band. After holding your arm still and straight for a short wait, you should see your heart rate again. If the heart rate signal is still missing, check your Heart Rate setting on your Fitbit dashboard and make sure it's set to On or Auto.

## Unexpected behavior

If you experience one of the following problems, it may be fixed by restarting your tracker:

- Not syncing despite successful setup
- Not responding to button presses or taps despite being charged
- Not tracking your steps or other data

---

**Note:** Restarting your tracker reboots the device but does not delete any data.

---

To restart your tracker:

1. Plug the charging cable into the USB port on your computer or a UL-certified USB wall charger.
2. Clip the other end of the charging cable to the port on the back of the tracker. The pins on the charging cable must lock securely with the port.

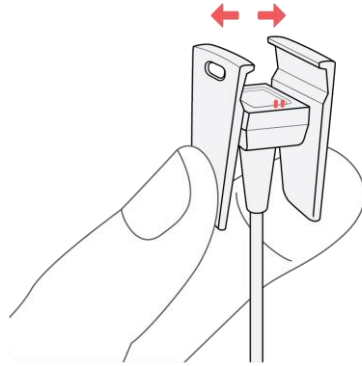

3. Make sure the button on your tracker is aligned with the button opening on the charging cable. You'll know the connection is secure when the tracker vibrates and you see a battery icon on your tracker's display. Your Charge 2 will begin charging.

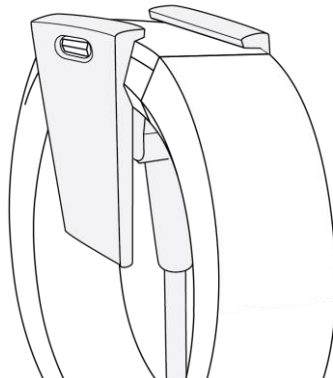

4. Press and hold the button on your tracker for four seconds. When you see the Fitbit logo and the tracker vibrates, this means the tracker has restarted.

After your tracker restarts you can unplug it from the charging cable and put it back on. For additional troubleshooting or to contact Customer Support, see [help.fitbit.com](https://help.fitbit.com).

# Fitbit Charge 2 General Info & Specifications

---

## Sensors

Your Charge 2 contains the following sensors:

- A MEMS 3-axis accelerometer, which tracks your motion patterns
- An altimeter, which tracks altitude changes
- An optical heart rate tracker

## Materials

The wristband that comes with Charge 2 is made of a flexible, durable elastomer material similar to that used in many sports watches. It does not contain latex. Accessory wristbands are available in genuine leather.

The buckle and frame on Charge 2 are made of surgical-grade stainless steel. While all stainless steel contains traces of nickel and can cause an allergic reaction in someone with nickel sensitivity, the amount of nickel in all Fitbit products meets the European Union's stringent Nickel Directive.

## Wireless technology

Charge 2 contains a Bluetooth 4.0 radio transceiver.

## Haptic feedback

Charge 2 contains a vibration motor, for alarms, goals, notifications, and reminders.

## Battery

Charge 2 contains a rechargeable lithium-polymer battery.

## Memory

Charge 2 stores most minute-by-minute stats and exercise data for seven days. It stores SmartTrack data for three days and summary totals for 30 days. Heart rate

data is stored at one-second intervals during exercise tracking and at five-second intervals at all other times.

Refer to the following table for information on how long Charge 2 stores your stats and data in between the times you sync your tracker. Stored data consists of steps, distance, calories burned, floors, active minutes, heart rate, exercise, sleep, and stationary vs. active hours.

Note that Charge 2 can store a maximum of 10 hours of exercise data. This means that if you exercise for more than 10 hours and don't sync your tracker, your exercise history will not include everything. We recommend syncing your tracker at least once a day.

Type of data	Days stored
Minute-by-minute stats	7
Sleep data	7
Sleep stages	5
SmartTrack data	7
Summary totals	30

## Display

The Charge 2 has an OLED tap display.

## Size

Wristband sizes are shown below. Note that accessory wristbands sold separately may vary slightly in size.

Small wristband

Fits a wrist between 5.5 and 6.7 inches in circumference

Large wristband

Fits a wrist between 6.7 and 8.1 inches in circumference

Extra large wristband

Fits a wrist between 8.1 and 9.3 inches in circumference

## Environmental conditions

Operating Temperature

14° to 113° F  
(-10° to 45° C)

Non-operating Temperature

-4° to 140° F  
(-20° to 60° C)

Water Resistant

Splash proof. Do not shower with the device or submerge it in water.

Maximum Operating Altitude

30,000 feet  
(10,000 m)

## Learn More

To learn more about your tracker and dashboard, visit [help.fitbit.com](http://help.fitbit.com).

## Return policy and warranty

Warranty information and the fitbit.com return policy can be found at <http://www.fitbit.com/returns>.

# Regulatory & Safety Notices

---

Model Name: FB407

## USA: Federal Communications Commission (FCC) statement

**Notice to the User:** The FCC and Industry Canada IDs can also be viewed on your device. To view content:

- While your tracker is charging, press the button to scroll to the Regulatory screen.

This device complies with FCC part 15 FCC Rules. Operation is subject to the following two conditions:

1. This device may not cause harmful interference and
2. This device must accept any interference received, including interference that may cause undesired operation

### FCC Warning

Changes or modifications not approved by Fitbit, Inc. could void the user's authority to operate the equipment.

**Note:** This equipment has been tested and found to comply with the limits for a Class B digital device, pursuant to part 15 of the FCC Rules. These limits are designed to provide reasonable protection against harmful interference in a residential installation. This equipment generates, uses and can radiate radio frequency energy and, if not installed and used in accordance with the instructions, may cause harmful interference to radio communications. However, there is no guarantee that interference will not occur in a particular installation. If this equipment does cause harmful interference to radio or television reception, which can be determined by turning the equipment off and on, the user is encouraged to try to correct the interference by one or more of the following measures:

- Reorient or relocate the receiving antenna
- Increase the separation between the equipment and receiver
- Connect the equipment into an outlet on a circuit different from that to which the receiver is connected.
- Consult the dealer or an experienced radio/TV technician for help.

This device meets the FCC requirements for RF exposure in public or uncontrolled environments.

FCC ID: XRAFB407

## Canada: Industry Canada (IC) statement

This device meets the IC requirements for RF exposure in public or uncontrolled environments.

Cet appareil est conforme aux conditions de la IC en matière de RF dans des environnements publics ou incontrôlée

IC Notice to Users in accordance with the current RSS GEN:

This device complies with Industry Canada license exempt RSS standard(s).

Operation is subject to the following two conditions:

1. this device may not cause interference, and
2. this device must accept any interference, including interference that may cause undesired operation of the device

Cet appareil est conforme avec Industrie Canada RSS standard exempts de licence (s). Son utilisation est soumise à Les deux conditions suivantes:

1. Cet appareil ne peut pas provoquer d'interférences et
2. Cet appareil doit accepter Toute interférence, y compris les interférences qui peuvent causer un mauvais fonctionnement du dispositif

IC: 8542A-FB407

## European Union (EU)

Simplified EU Declaration of Conformity

Hereby, Fitbit, Inc. declares that the radio equipment type Model FB407 is in compliance with Directive 2014/53/EU. The full text of the EU declaration of conformity is available at the following internet address:

<http://www.fitbit.com/safety>.

Déclaration UE de conformité simplifiée

Fitbit, Inc. déclare par la présente que les modèles d'appareils radio FB407 sont conformes à la Directive 2014/53/UE. Les déclarations UE de conformité sont disponibles dans leur intégralité sur le site suivant: [www.fitbit.com/safety](http://www.fitbit.com/safety).

Dichiarazione di conformità UE semplificata

Fitbit, Inc. dichiara che il tipo di apparecchiatura radio Modello FB407 è conforme alla Direttiva 2014/53/UE. Il testo completo della dichiarazione di conformità UE è disponibile al seguente indirizzo Internet: [www.fitbit.com/safety](http://www.fitbit.com/safety).

Vereinfachte EU-Konformitätserklärung

Fitbit, Inc. erklärt hiermit, dass die Funkgerätypen Modell FB407 die Richtlinie 2014/53/EU erfüllen. Der vollständige Wortlaut der EU-Konformitätserklärungen kann unter folgender Internetadresse abgerufen werden: [www.fitbit.com/safety](http://www.fitbit.com/safety).

Declaración UE de Conformidad simplificada

Por la presente, Fitbit, Inc. declara que el tipo de dispositivo de radio Modelo FB407 cumple con la Directiva 2014/53/UE. El texto completo de la declaración de conformidad de la UE está disponible en la siguiente dirección de Internet: [www.fitbit.com/safety](http://www.fitbit.com/safety).



## Australia and New Zealand

Notice to the User: Regulatory content for this region can also be viewed on your device. To view the content:

- While your tracker is charging, press the button to scroll to the Regulatory screen.



**R-NZ**

## China





部件名称	有毒和危险品					
	铅 (Pb)	水银 (Hg)	镉 (Cd)	六价铬 (Cr(VI))	多溴化苯 (PBB)	多溴化二苯醚 (PBDE)
<b>Charge 2 Model FB407</b>						
表带和表扣	○	○	○	○	○	○
电子	X	○	○	○	○	○
电池	○	○	○	○	○	○
充电线	X	○	○	○	○	○
<p>本表格依据 SJ/T 11364 的规定编制</p> <p>○: 表示该项目中涉及的所有物料, 其包含的有害物质的含量低于 GB/T 26572. 标准的限制要求.</p> <p>X: 表示该项目中涉及的所有物料中至少有一种, 其包含的有害物质的含量高于 GB/T 26572. 标准的限制要求.</p>						

## Israel

התאמה אישור 51-54765  
המוצר של המודולארי בחלק טכני שינוי כל לבצע אי.

## Japan

Notice to the User: Regulatory content for this region can also be viewed on your device. To view the content:

- While your tracker is charging, press the button to scroll to the Regulatory screen.



201-160320

## Mexico



IFETEL: RCPFIFB16-0649

La operación de este equipo está sujeta a las siguientes dos condiciones:

1. Es posible que este equipo o dispositivo no cause interferencia perjudicial y
2. Este equipo o dispositivo debe aceptar cualquier interferencia, incluyendo la que pueda causar su operación no deseada

## Morocco

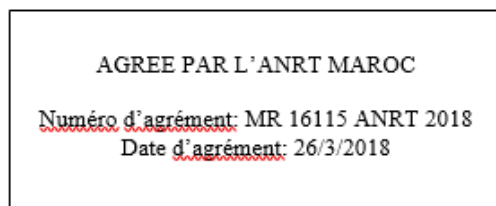

## Oman

OMAN-TRA/TA-R/3338/16  
D090258

## Philippines



## Serbia



## Singapore

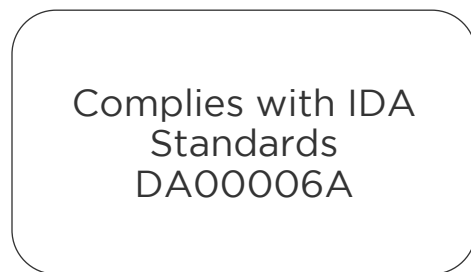

## South Africa

Notice to the User: Regulatory content for this region can also be viewed on your device. To view the content:

- While your tracker is charging, press the button to scroll to the Regulatory screen.



TA-2016/1368

## South Korea

Notice to the User: Regulatory content for this region can also be viewed on your device. To view the content:

- While your tracker is charging, press the button to scroll to the Regulatory screen.

클래스 B 장치 (가정 사용을 위한 방송 통신 기기) : EMC 등록 주로 가정용 (B 급)으로하고, 모든 지역에서 사용할 수 있습니다. **열을 이 장치. “ 해당 무선설비는 전파혼신 가능성이 있으므로 인명안전과 관련된 서비스는 할 수 없습니다. ”**

- 사용 주파수 (Used frequency): 2402 MHz-2480 MHz
- 채널수 (The number of channels): 40
- 공중선전계강도 (Antenna power): -2.0dBi
- 변조방식 (Type of the modulation): Digital
- 안테나타입 (Antenna type): Vertical
- 출력 (Output power): 0.032mW
- 안테나 종류 (Type of Antenna): Stamped Metal

**KCC approval information**

- 1) Equipment name (model name) : 무선데이터통신시스템용 특정소출력무선기기 FB407
- 2) Certificate number: MSIP-CMM-XRA-FB407
- 3) Applicant: Fitbit, Inc.
- 4) Manufacture: Fitbit, Inc.
- 5) Manufacture / Country of origin: P.R.C.

## Taiwan

### Fitbit Model FB407

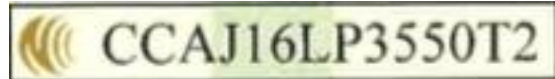

注意！

依據 低功率電波輻射性電機管理辦法

第十二條 經型式認證合格之低功率射頻電機，非經許可，公司、商號或使用者均不得擅自變更頻率、加大功率或變更原設計之特性及功能

第十四條

低功率射頻電機之使用不得影響飛航安全及干擾合法通信；經發現有干擾現象時，應立即停用，並改善至無干擾時方得繼續使用。

前項合法通信，指依電信法規定作業之無線電通信。

低功率射頻電機須忍受合法通信或工業、科學及醫療用電波輻射性電機設備之干擾。

### Article 12

Without permission, any company, firm or user shall not alter the frequency, increase the power, or change the characteristics and functions of the original design of the certified lower power frequency electric machinery.

#### Article 14

The application of low power frequency electric machineries shall not affect the navigation safety nor interfere a legal communication, if an interference is found, the service will be suspended until improvement is made and the interference no longer exists. The foregoing legal communication refers to the wireless telecommunication operated according to the telecommunications laws and regulations. The low power frequency electric machinery should be able to tolerate the interference of the electric wave radiation electric machineries and equipment for legal communications or industrial and scientific applications.

## United Arab Emirates

TRA Registered No.: ER46380/16  
Dealer No.: DA35294/14

## Safety statement

This equipment has been tested to comply with safety certification in accordance with the specifications of EN Standard: EN60950-1:2006 + A11:2009 + A1:2010 + A12: 2011 + A2:2013.

©2018 Fitbit, Inc. All rights reserved. Fitbit and the Fitbit logo are trademarks or registered trademarks of Fitbit in the US and other countries. A more complete list of Fitbit trademarks can be found at <http://www.fitbit.com/legal/trademark-list>. Third-party trademarks mentioned are the property of their respective owners.